

Kulp Lights

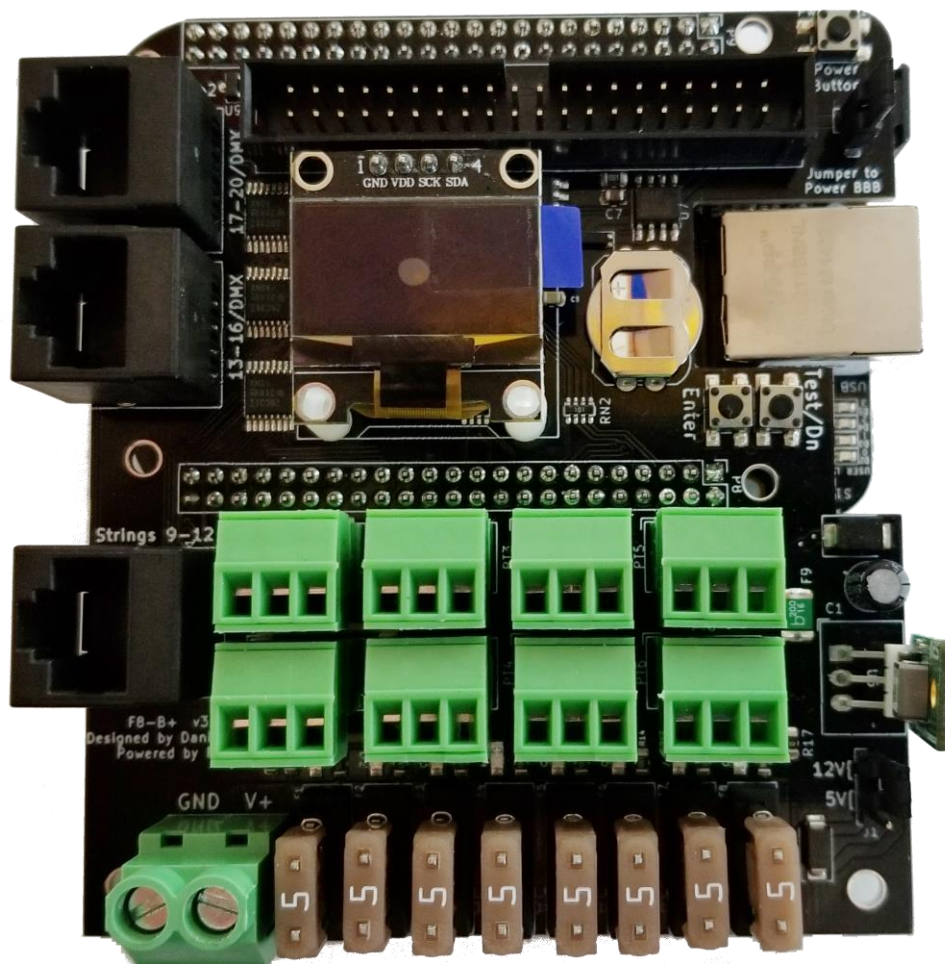

F8-B Controller Owner's Manual



Introduction

Welcome to the KulpLights line of pixel controllers. These controllers were designed to meet the different needs of the lighting enthusiasts that could not be met with the existing controllers on the market. Due to the extreme variations that lighting enthusiasts use to control their displays, these controllers were designed to support many different display configurations and lighting needs.

Enjoy your new controller!

Table of Contents

F8-B Controller.....	1
Introduction.....	2
Overview.....	5
Specifications.....	7
Quick Start Guide.....	8
Required hardware.....	8
Optional hardware.....	8
Required Software.....	8
Configuring the Micro SD (uSD) Card.....	9
Getting the FPP software.....	9
Software Installation.....	11
USB Tethering.....	12
Initial Configuration.....	12
Initial Network Configuration.....	15
Wi-Fi Network settings.....	16
Ethernet Network Settings.....	17
Host & DNS Settings.....	17
Final configurations.....	19
Input/Output Settings.....	25
Channel Inputs.....	25
Adding E1.31 Bridge Mode Input.....	26
Channel Outputs.....	27
BBB Strings.....	28
Network Installation.....	31
OLED Operation.....	31
Standby Screen.....	33
Main Menu.....	34
Start Playlist.....	34
FPPD Mode.....	35
Tethering.....	35
Testing.....	36
Reboot.....	37

Shutdown.....	37
About	37
Troubleshooting.....	38

Overview

The F8-B requires a BeagleBone Black or BeagleBone Green (not the wireless version)

F8-B without the OLED Display installed.

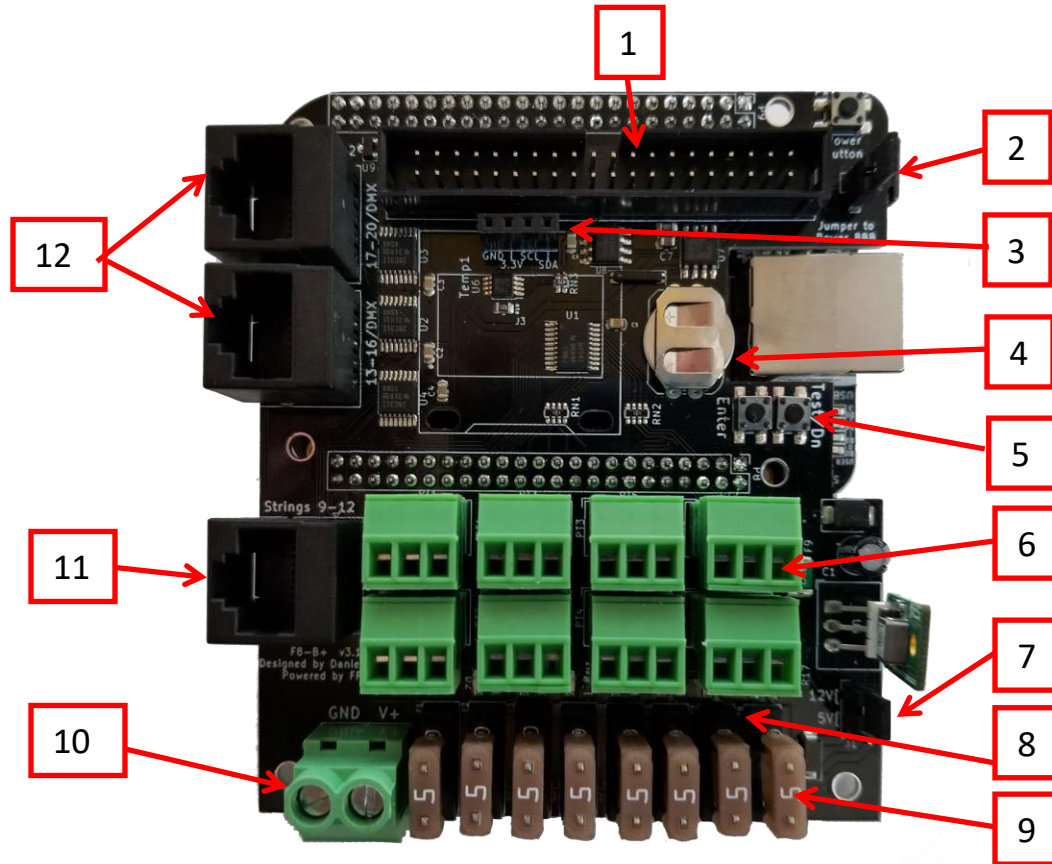

1. 40 Pin Expansion Header- to connect a differential expansion or expansion board.
2. Jumper to select if you want to power the BB from the power connected to the controller.
3. I2C port for connecting an OLED display.
4. Battery for Real Time Clock (CR1220).
5. OLED Navigation buttons- Used for navigating through the menu items in the OLED screen.
6. Pixel Connection Ports- There are 8 ports for connecting pixel strings.
7. Voltage Selector Jumpers- The jumpers are for selecting the input voltage.
8. Fuse Indicator LEDs- Each port has an indicator LED to indicate if the fuse is good.
9. Fuses- Each output is individually fused.
10. Voltage connector- The F8-B can be powered by 12 or 5V.
11. Differential Expansion Port- Used to connect a differential receiver.
12. RJ45 Multi-Function ports- can be configured for various outputs such as differential expansion, DMX, PixelNet, etc.

BeagleBone Black Diagram (Front)

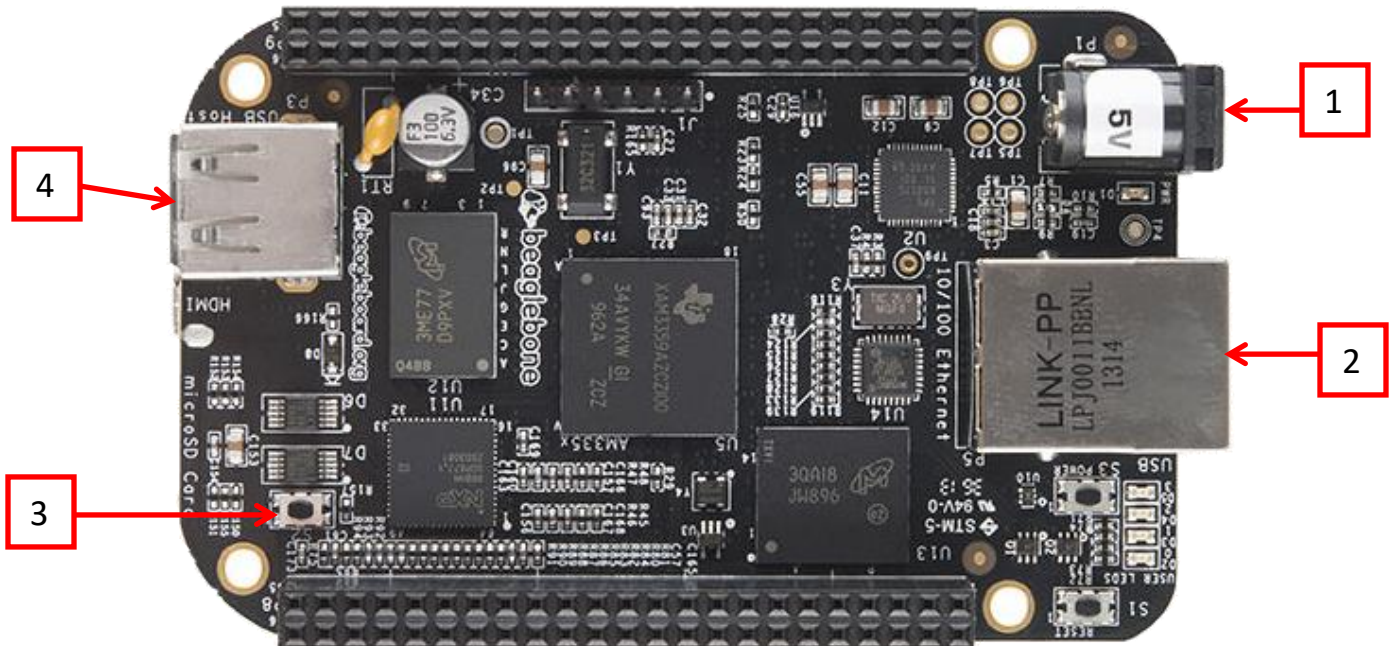

1. 5V Barrel connector- used to power the BeagleBone. You can power your Beaglebone from the F8-B controller if you want by setting the jumper correctly. This is NOT for powering the F8-B as well.
2. 10-100 Ethernet port.
3. S2 Button- This is used for the first installation of the FPP Software.
4. USB Port

BeagleBone Black Diagram (Rear)

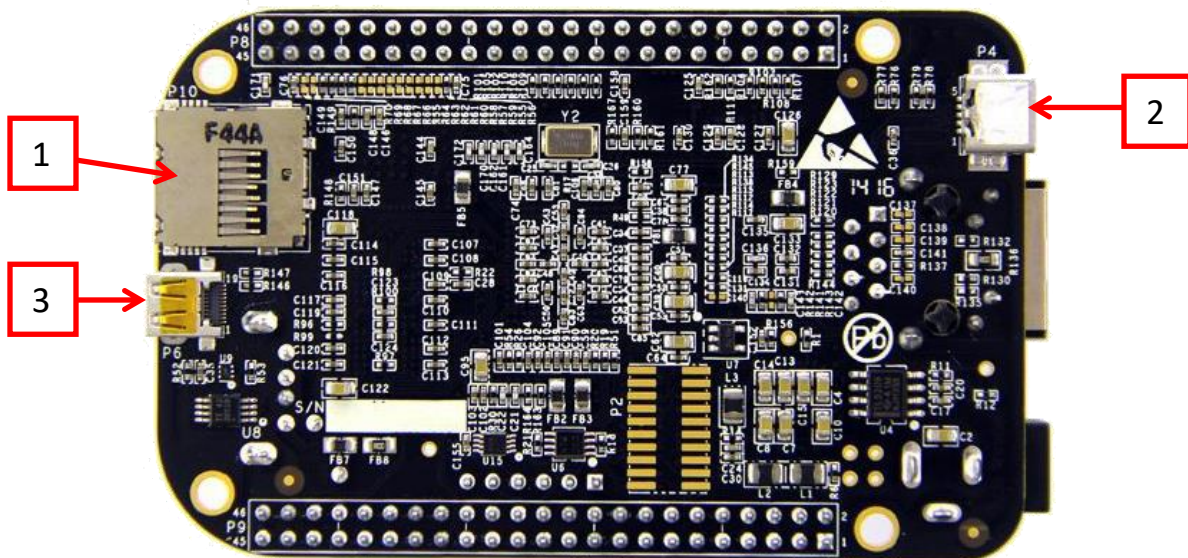

1. Micro SD Card Slot- Location where you need to insert the Micro SD (uSD) Card.
2. Mini USB port- This can be used for the initial software installation and configuration.
3. HDMI port- This is not used for the F8-B

Specifications

8 fused pixel ports for controlling 750 pixels¹ at 40 frames per second (1400 pixels¹ at 20 frames per second)

1 RJ45 port (labeled Strings 9-12) this RJ45 connection can control 4 pixel ports and each pixel port can control 700 pixels¹ at 40 frames per second (1400 pixels¹ at 20 frames per second) using a Differential Receiver.²

If you are using a Smart Receiver², then each pixel port can control 640 pixels at 40 frames per second per port group combined (i.e. 9A, 9B, and 9C are one port group and can control up to 640 pixels) and 1340 pixels at 20 frames per second per port group.

2 RJ45 connections (labeled 13-16/DMX and 17-20/DMX)

- If used for pixel output- Each of these RJ45 ports can control 4 pixel ports and each pixel port can control 700 pixels¹ at 40 frames per second (1400 pixels¹ at 20 frames per second) using a Differential Receiver.³

If you are using a Smart Receiver², then each pixel port can control 640 pixels at 40 frames per second per port group combined (i.e. 9A, 9B, and 9C are one port group and can control up to 640 pixels) and 1340 pixels at 20 frames per second per port group.

- Used for DMX/Pixelnet output- Each RJ45 port can control 4 DMX/Pixelnet Universes (1 Universe per wire pair.)

Expansion Header

- Expansion Board²- Can control an additional 700 pixels¹ at 40 frames per second (1400 pixels¹ at 20 frames per second) per each pixel port (there are 16 pixel ports on the Expansion board).
- Differential Expansion Board²- Can control an additional 700 pixels¹ at 40 frames per second (1400 pixels¹ at 20 frames per second) per pixel port on the Differential Receivers² (if you are using a Smart Receiver², then it is 640 pixels at 40 frames per second and 1340 pixels at 20 frames per second distributed among each Smart Receiver pixel port group, i.e. 9A, 9B, and 9C are a port group).

¹ The controller can supply the data for the specified number of pixels but depending on your configuration, voltage, etc. you will probably need to power inject.

² Differential Receivers, Smart Receivers, Expansion Board and Differential Expansion boards are available at PixelController.com

³ Differential Receivers, Smart Receivers, Expansion Board and Differential Expansion boards are available at PixelController.com

Quick Start Guide

The following section will guide you through installing the FPP Software and the initial configuration of your F8-B. If you are going to use the USB Tethering method for installation, it is recommended to do so without the F8-B controller attached.

Required hardware

You will need the following hardware to configure your F8-B:

- F8-B with BeagleBone installed.
- USB Wi-Fi adapter- If you are going to connect your F8-B to your network via Wi-Fi (Edimax Nano is recommended but it is best to stick with a 2.4Ghz only, some of the 5Ghz cards have compatibility issues.)
- Micro SD (uSD) card- Class 10 type, 8GB minimum 128GB maximum. **You want to get a good quality uSD card because this is the heart of your controller.**

Optional hardware

Depending on how you are going to use your F8-PB, there is some additional hardware that you might need.

- Mini USB to USB cable (If you are going to use the USB Tethering installation method).
- USB Audio Soundcard- If you are going to use your F8-B to output audio then you will need a sound card, something like the Sound Blaster Play 3.
- USB Hub- If you need more USB ports for other peripherals (not common).

Required Software

To install the software, you will need a couple programs, one for formatting the MicroSD card and one for “burning” the image.

Note: You cannot just copy the files to the card!

If you don't have the programs to accomplish this, here are a couple suggestions:

An SD card formatter

<https://www.sdcard.org/downloads/index.html> has a version for both Mac and Windows.

<https://gparted.org/> has a version for Linux systems.

An image writer program

<https://www.balena.io/etcher/> has a version for Windows, Mac and Linux operating systems.

<https://sourceforge.net/projects/dotnetdiskimager/> is a good option for Windows users.

If you don't know how you are going to use FPP in your network, you should refer to the [Common Network Setups](#) section of the FPP manual.

Configuring the Micro SD (uSD) Card

After you have installed the two programs listed above (or use the versions that you have), then insert the MicroSD (uSD) card into your computer and do a Quick Format using the Formatting software (Not Windows or MAC file managers).

Below is a Windows screenshot as an example.

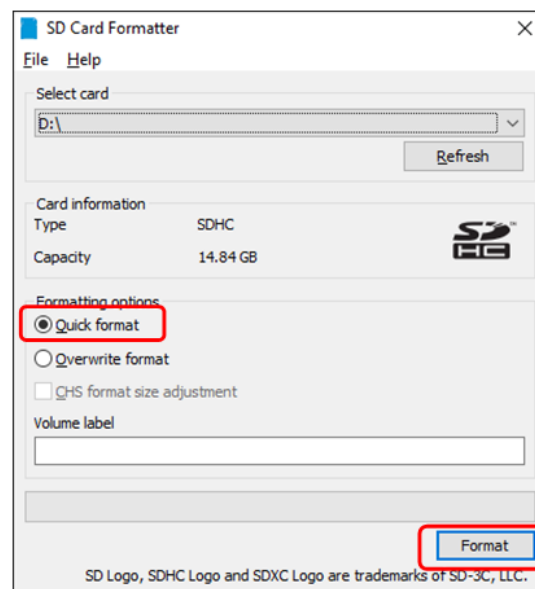

Getting the FPP software

You will then need to go to <https://github.com/FalconChristmas/fpp/releases> and download **the most current Image File, not the source code for your application! The Image file has the .img.zip in the file name.**

The Image Files are the files that start with FPP and then indicates the version and SBC image. Download the file that has the BBB in the name. On the Github website there will be several releases listed. Not all of them have an image available. Scroll down until you find the first version with the images.

Note: you might have to expand the Assets section to see if an image is available.

Here is an example of the most current release as of February 2020 (pick the most current release for your application)

Before expanding:

Upgrade Instructions:

If you have a system running 3.5.x or 3.6.x, you can go to the FPP about page (about.php) and click on the "Manual Update" button. It should only take a minute or two to upgrade.

For older versions, it's recommended to grab the 3.6.1 image from the bottom of <https://github.com/FalconChristmas/fpp/releases/tag/3.6.1> , install that.

▶ Assets 4

After Expanding:

Upgrade Instructions:

If you have a system running 3.5.x or 3.6.x, you can go to the FPP about page (about.php) and click on the "Manual Update" button. It should only take a minute or two to upgrade.

For older versions, it's recommended to grab the 3.6.1 image from the bottom of <https://github.com/FalconChristmas/fpp/releases/tag/3.6.1> , install that.

▼ Assets 4

 FPP-v3.6.1-BBB.img.zip	1.03 GB
 FPP-v3.6.1-Pi.img.zip	1.02 GB
 Source code (zip)	
 Source code (tar.gz)	

Depending on your image-writing software, you may have to unzip the file before you can use it.

Once you have downloaded the zip file for your application, you might have to extract the file first, depending on your imaging program. Then you have to burn the image onto the uSD card using the software for burning images (in this case, I am using Etcher) Make sure you are flashing the .img file and not the .zip file if your imaging software does not support imaging from a .zip file. If you are not sure, unzip the file first.

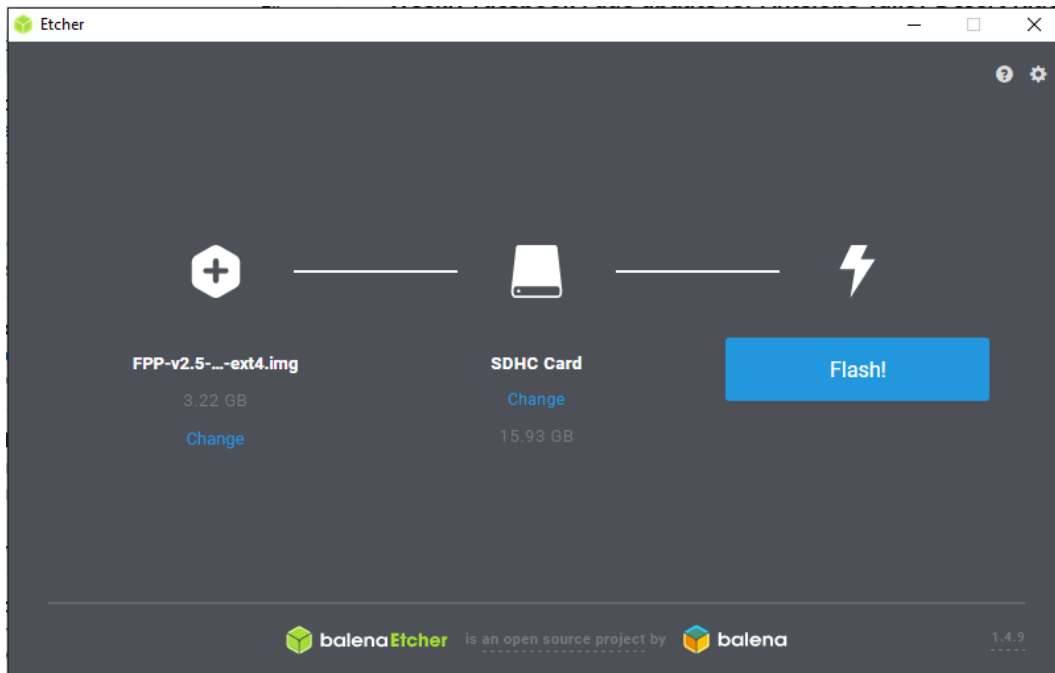

The image that is burned onto the card is not in a format that Windows or Macs can read so you might get an error message after the image is burned. DO NOT perform the format process after you have loaded the image.

Once you have the image file on the uSD card, make sure your F8-B is turned off and insert the uSD card into your F8-B.

The easiest way to install and configure your F8-B is by using the USB Tethering method. If you want to use another method to install and configure your F8-B, refer to the [Network Installation](#) method.

Note: The F8-B has RJ45 ports but they are NOT Ethernet ports, they are used for DMX or Differential Receivers. They are not network connections and you cannot use these ports for initial setup.

Software Installation

FPP is configured from a Web based interface, you can't access FPP directly using a keyboard and monitor connected to the BeagleBone!

You will access the FPP interface from your computer using a web browser.

Note: Google Chrome is recommended. Internet Explorer and Microsoft Edge have problems displaying the interface correctly.

Before you begin the software installation and configuration process, you should decide how you are ultimately going to have your F8-B connected to your network, either Wi-Fi, Ethernet, or in a few cases both. And then make sure that your F8-B has the appropriate adapter installed prior to installing/configuring FPP. You also need to know what your home network router's IP address is (the 2 most common ones are 192.168.0.1 and 192.168.1.1 but there are many other common ones as well)

Note: If your home router has an IP address with a subnet of 192.168.6.xxx, 192.168.7.xxx or 192.168.8.xxx then your FPP will have problems communicating in these environments. Those subnets are the default subnets used by Windows, Mac and Linux for USB tethering and could cause conflicts. You should change your home network to a different subnet to avoid problems.

If you don't know how you are going to use FPP in your network, you should refer to the [Common Network Setups](#) section of the FPP manual.

The following steps are a suggested method of installing the software on your F8-PB.

USB Tethering

USB Tethering is probably the easiest method to install and configure your F8-B. To install and configure your F8-B using USB Tethering, you will connect your computer directly to the F8-B with a USB cable. It is recommended to remove the F8-B controller from the BeagleBone Black before you start the installation process.

Note: Make sure you have the appropriate adapter for the network connection that you are going to use for your network connection, then make sure it is installed before you start your setup.

1. Make sure the uSD card with the proper image is inserted into the slot.
2. Make sure you have any network adapters that you will need for your network configuration.
3. Connect one end of the USB cable to your computer.
4. Plug the USB cable into the FPP device.
5. Wait approximately one minute.
6. Open a web browser on your computer and if you are using a Windows computer, then enter 192.168.7.2 in the browser's address bar, if you are using a Mac or Linux computer then enter 192.168.6.2.

Initial Configuration

Once the FPP has been installed on your F8-B, then you need to complete your setup.

Your screen will look similar to this.

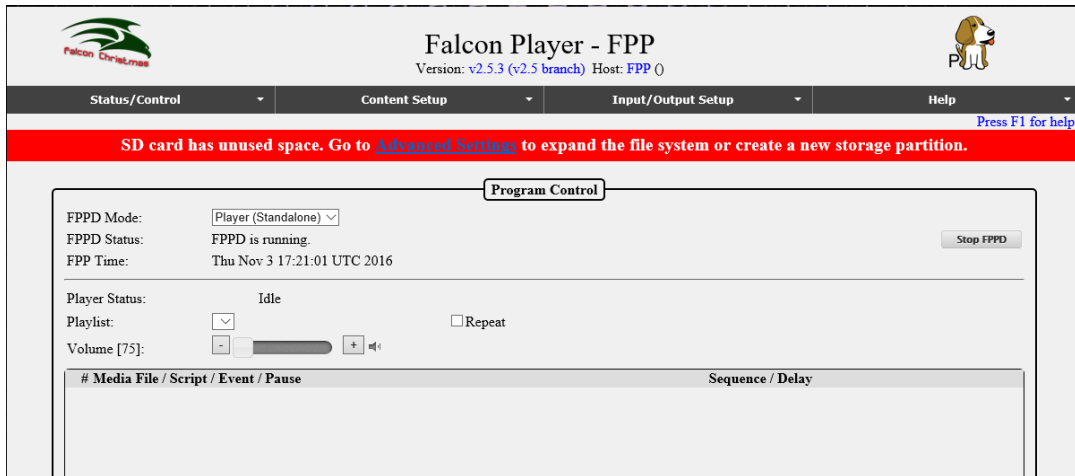

Click on the Advanced Settings that is in the red banner.

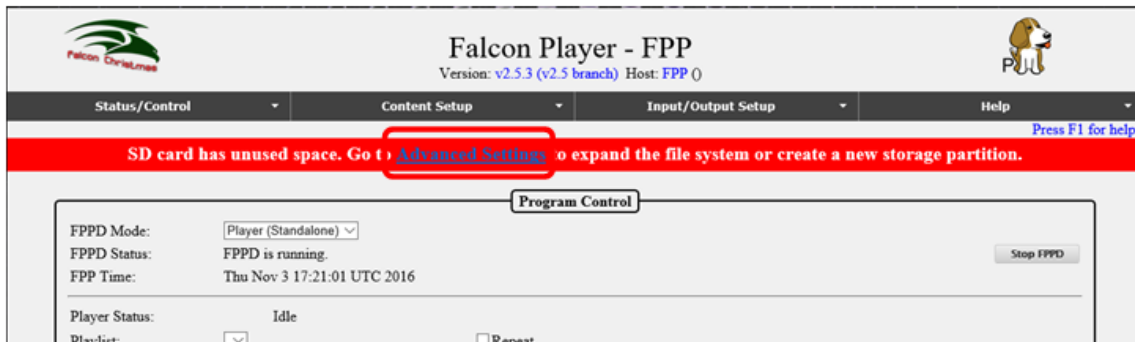

Click on the Grow Filesystem button.

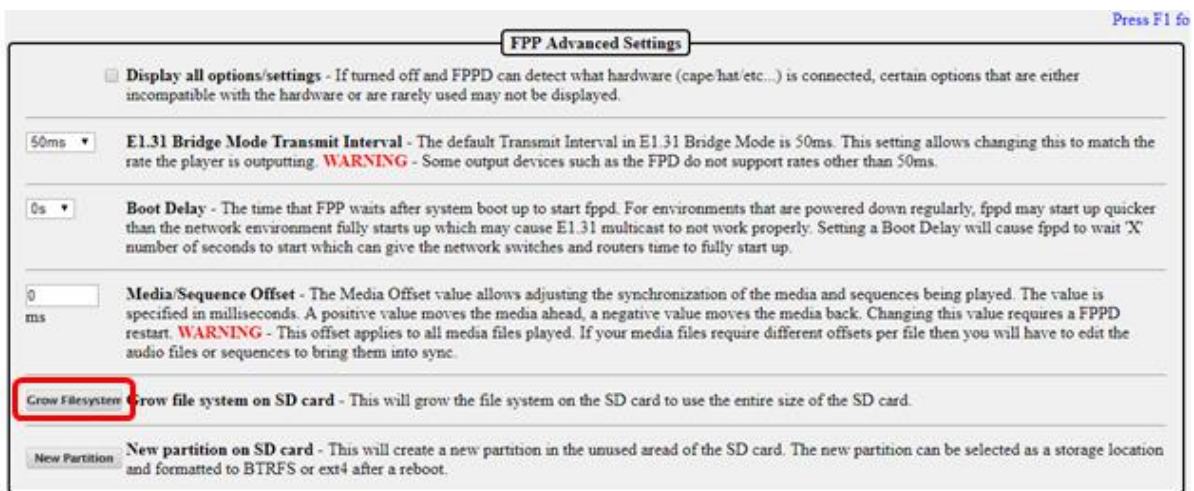

This should bring you to this screen, click on Yes:

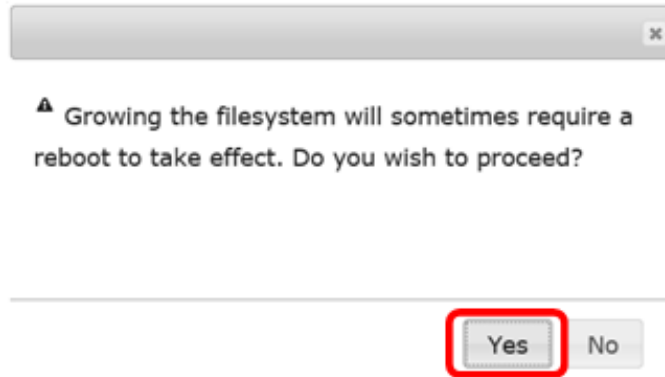

You should get to a screen similar to this:

Grow SD Card Filesystem

Command: `sudo /usr/bin/raspi-config --expand-rootfs`

Welcome to fdisk (util-linux 2.33.1).
Changes will remain in memory only, until you decide to write them.
Be careful before using the write command.

Command (m for help): Disk /dev/mmcblk0: 58.2 GiB, 62537072640 bytes, 122142720 sectors
Units: sectors of 1 * 512 = 512 bytes
Sector size (logical/physical): 512 bytes / 512 bytes
I/O size (minimum/optimal): 512 bytes / 512 bytes
Disklabel type: dos
Disk identifier: 0x17869b7d

Device	Boot	Start	End	Sectors	Size	Id	Type
/dev/mmcblk0p1		8192	532480	524289	256M	c	W95 FAT32 (LBA)
/dev/mmcblk0p2		540672	7708671	7168000	3.4G	83	Linux

Command (m for help): Partition number (1,2, default 2):
Partition 2 has been deleted.

Command (m for help): Partition type
p primary (1 primary, 0 extended, 3 free)
e extended (container for logical partitions)

Select (default p): Partition number (2-4, default 2): First sector (2048-122142719, default 2048): Last sector,
Created a new partition 2 of type 'Linux' and of size 58 GiB.

Command (m for help):
Disk /dev/mmcblk0: 58.2 GiB, 62537072640 bytes, 122142720 sectors
Units: sectors of 1 * 512 = 512 bytes
Sector size (logical/physical): 512 bytes / 512 bytes
I/O size (minimum/optimal): 512 bytes / 512 bytes
Disklabel type: dos
Disk identifier: 0x17869b7d

Device	Boot	Start	End	Sectors	Size	Id	Type
/dev/mmcblk0p1		8192	532480	524289	256M	c	W95 FAT32 (LBA)
/dev/mmcblk0p2		540672	122142719	121602048	58G	83	Linux

Command (m for help): The partition table has been altered.
Syncing disks.

Please reboot

[Go to FPP Main Status Page](#)

Click on the “Go to FPP Main Status Page” to go back to your FPP main page.
When you get back to the main screen, click on the Reboot button

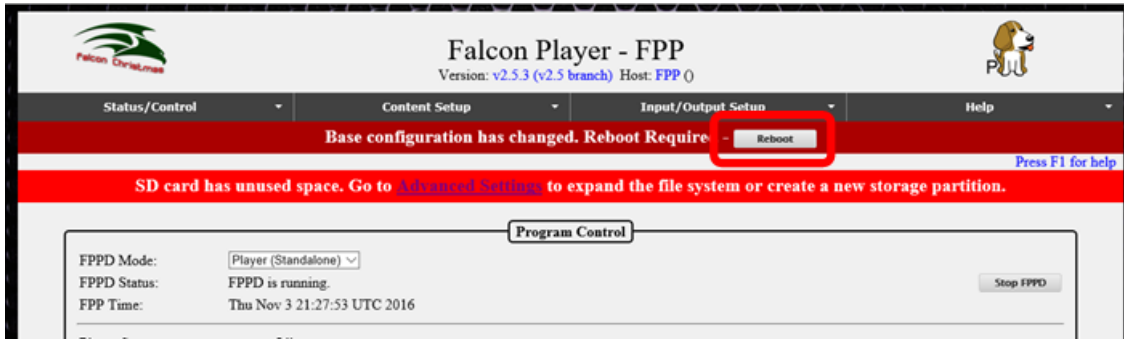

You will get a confirmation screen, click on “OK”

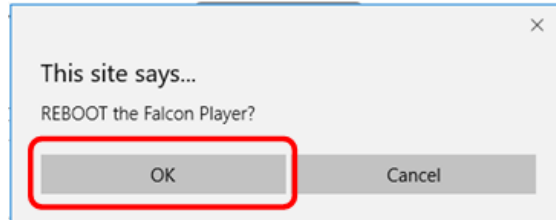

It will take several seconds for it to reboot. After it reboots, you will need to set up other configurations and update the system to the current version. This is covered in the next section.

Initial Network Configuration

You should have decided how you want your network configured before you edit your network settings. If you are not sure, then refer to the [Network Configuration](#) section of the FPP Manual for more information. If you want a temporary network configuration you can use the [Wired with Separate Show Network](#) configuration so that you update the software and make final configurations before use the F8-B in your final network configuration. This would be a good configuration for testing purposes as well.

Click on the Status/Control and then Network tab.



You should have a screen similar to this:

Network Configuration

Interface Settings

WIFI Drivers:

Select an interface name to configure the network information for that interface.

Interface Name:

Interface Mode: Static DHCP

IP Address:

Netmask:

Gateway:

Wireless Settings:

WPA SSID: Hidden

WPA Pre Shared key (PSK):

Host & DNS Settings

HostName:

Description:

DNS Server Mode: Manual DHCP

DNS Server 1:

DNS Server 2:

Wi-Fi Network settings

If you do not need to configure a Wi-Fi connection, then skip to the [Ethernet Network Settings](#) section.

Note: It is not recommended to use a 5 GHz Wireless network as the transmission distance is less than the 2.4 GHz and not all devices support 5 GHz.

Normally the External Wi-Fi drivers work best so keep that setting.

1. Click on the wlan0 interface (wlan0 is the wireless interface)
2. Select DHCP if you want your router to assign the IP address, select Static if you want to assign the IP address yourself. (Static is recommended)
Note: If you use DHCP, then the Host Name and DNS server is important to be configured correctly.
3. If you selected the Static option, enter your IP address, the Netmask should be 255.255.255.0 and the Gateway will be the IP address of your home or show router and will usually get filled in, but make sure it is correct.
4. Enter your WPA SSID and WPA Pre Shared Key (PSK). The WPA SSID is the name of your wireless network. The WPA Pre Shared key (PSK) is the password for your wireless network.
5. After you enter your wireless name and password, click on Update Interface
6. The Restart Network button will appear. **Do Not click on the Restart Network button.**

The screenshot shows the 'Interface Settings' window in a network configuration tool. At the top, there are tabs for 'Network Configuration' and 'Interface Settings'. Below the tabs, the 'WiFi Drivers' dropdown is set to 'External'. A message says 'Select an interface name to configure the network information for that interface.' The 'Interface Name' dropdown is set to 'wlan0'. Under 'Interface Mode', the 'Static' radio button is selected. Below this are input fields for 'IP Address', 'Netmask', and 'Gateway', each with a 'Ping' button to its right. The 'Wireless Settings' section includes a 'WPA SSID' field with a 'Hidden' checkbox and a 'WPA Pre Shared key (PSK)' field. At the bottom, there are three buttons: 'Update Interface', 'Create Persistent Names', and 'Clear Persistent Names'.

Ethernet Network Settings

If you do not need to configure an Ethernet connection, then skip to the [Host & DNS Settings](#) section.

1. Click on the eth0 interface (eth0 is the wired interface)
2. Select DHCP if you want your router to assign the IP address, select Static if you want to assign the IP address yourself. (Static is recommended)
3. If you selected the Static option, enter your IP address, the Netmask will be 255.255.255.0 and will get filled in automatically.
4. **If you are using both network interfaces** (wlan0 and eth0) such as connecting to your home network through Wi-Fi and connecting to a controller or switch through the eth0 interface then **make sure the Gateway is left blank**.
5. If you selected the Static option and are not using the wlan0 interface, the Gateway will be the IP address of your home or show router and will usually get filled in, but make sure it is correct.
6. After you made sure that you have the correct Gateway address, click on Update Interface.
7. The Restart Network button will appear. **Do Not click on the Restart Network button.**

Host & DNS Settings

The HostName is the “human” name that you can use to access your FPP. It is like typing google.com instead of typing 172.217.3.174 but be aware that if you don’t have a proper DNS server set up or another part of your network isn’t configured properly, then the HostName might not work properly but you will still be able to access the FPP by typing in the IP address. You will need to change the HostName to something that is meaningful to you. Something like FPPMaster, FrontLawn, HouseOutline, whatever fits your situation and makes sense to you. If you are not going to have any other FPP instances then you can keep it as FPP if you want but it is not recommended because in this hobby, people have a tendency to expand their show and

it is highly recommended that you rename it so there will be no confusion in the future. The HostName can only have letters, numbers, and hyphens (-). It may not begin or end with a hyphen and cannot have any spaces. Once you change the HostName you will no longer be able to access it in your web browser using <http://fpp.local/>. You can access it using the name that you just created or the IP address, that is why the name should make sense to you. Make sure you save your name after entering it. So if you changed the HostName to YardProps, then you could access the FPP by typing <http://Yardprops>. You can also add more descriptive information about this FPP in the Description box that will show up in other sections of FPP such as Multisync.

Network Configuration Press F1 for help

Interface Settings

WIFI Drivers: External

Select an interface name to configure the network information for that interface.

Interface Name: wlan0

Interface Mode: Static DHCP

IP Address: Ping

Netmask: Ping

Gateway: Ping

Wireless Settings:

WPA SSID: HarrisChristmas Hidden

WPA Pre Shared key (PSK): 6618163951

Update Interface

Host & DNS Settings

HostName: YourMeaningfullName Save

Description: Save

Once you have configured all of your network settings, eth0, wlan0, Host and DNS, double check them to make sure they are correct. If they are correct, then click on the Restart Network button. You will get the following message:

Warning: Reconfiguring the network will cause you to lose your connection and have to reconnect if you have changed the IP address. Do you wish to proceed?

Yes Cancel and apply at next reboot

Click on the Yes button.

At this point, your FPP will need to be connected to your network based on the configuration you set it for during the installation with the F8-B controller attached if you previously removed it.

Final configurations

Once you have your FPP connected to the network based on the configuration you entered in your network settings, you will have to open the F8-B's web page. Depending on how you configured your settings the process to get to your F8-B's page might be different. Usually you can get to it by typing the Host Name or IP address that you configured. If you cannot get to the FPP page, refer to the [Troubleshooting](#) section.

The next step is to configure your time settings, click on Status/Control and then Config/Set Time.

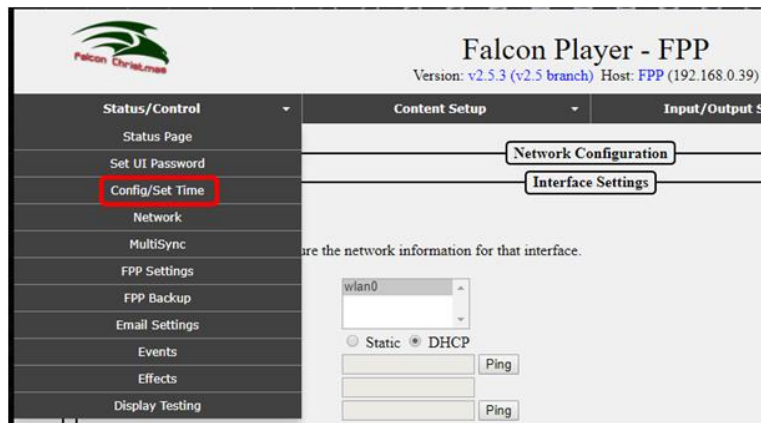

This will get you to this page. In most setup configurations, the FPP will have access to the internet and you can use the internet to keep the correct time.

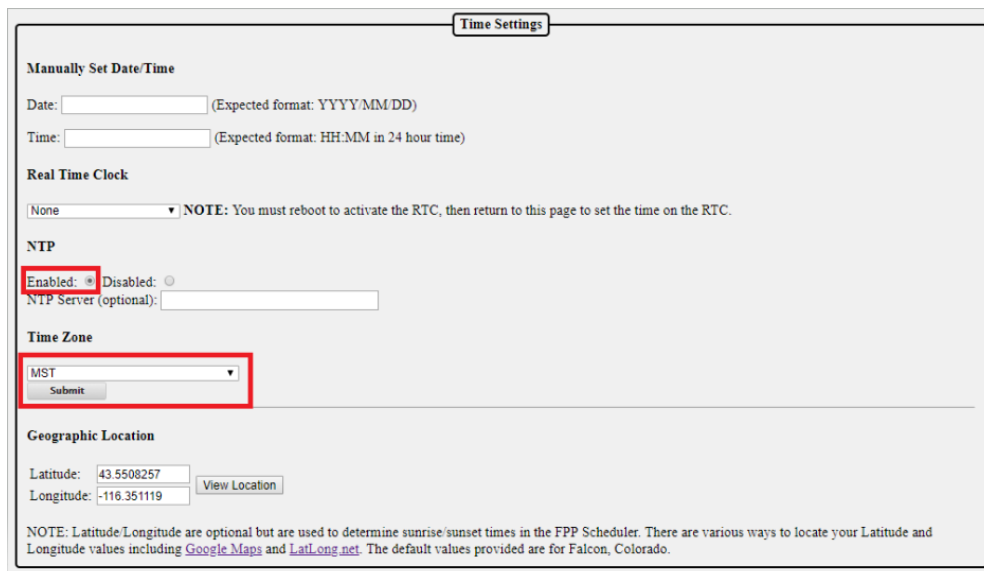

Time Settings

Manually Set Date/Time

Date: (Expected format: YYYY/MM/DD)

Time: (Expected format: HH:MM in 24 hour time)

Real Time Clock

NOTE: You must reboot to activate the RTC, then return to this page to set the time on the RTC.

NTP

Enabled: Disabled:

NTP Server (optional):

Time Zone

Geographic Location

Latitude:

Longitude:

NOTE: Latitude/Longitude are optional but are used to determine sunrise/sunset times in the FPP Scheduler. There are various ways to locate your Latitude and Longitude values including [Google Maps](#) and [LatLong.net](#). The default values provided are for Falcon, Colorado.

To use the internet to keep accurate time, (the recommended method) select Enabled for the NTP and select the correct time zone. NTP is Network Time Protocol and will get the current time from the internet.

If your F8-B will not have access to the internet, then you can manually set the date and time. Version 2 of the F8-B has a Real Time Clock installed. To use the on-board RTC, select the Adafruit PiRTC (pcf8523). Disable the NTP and reboot the F8-B.

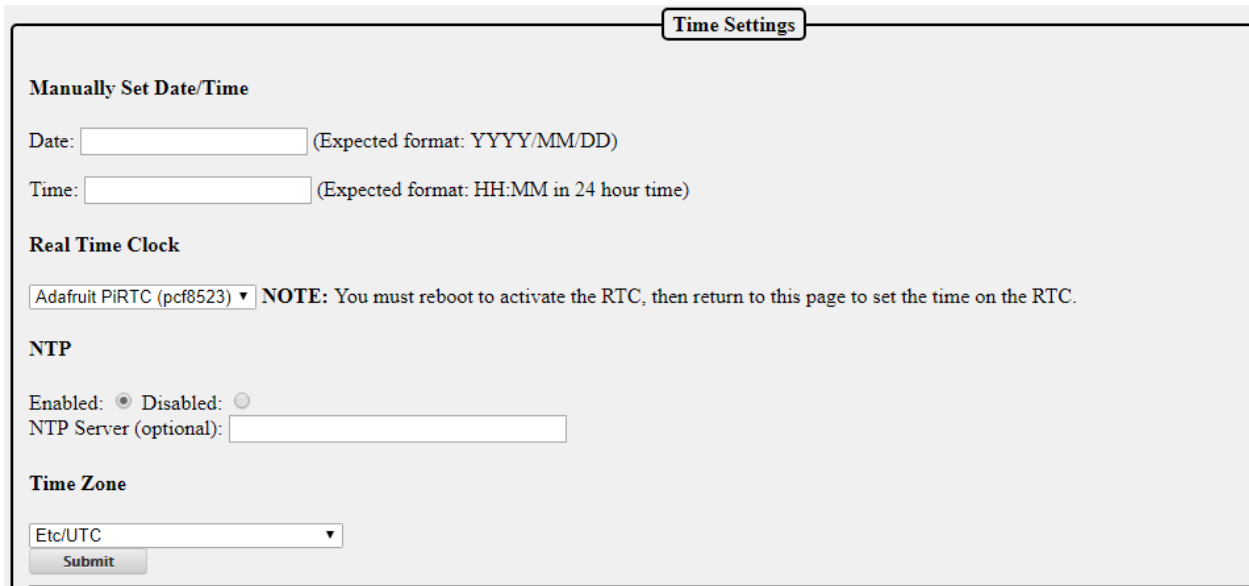

The screenshot shows a web interface titled "Time Settings". It has several sections: "Manually Set Date/Time" with input fields for "Date:" (format: YYYY/MM/DD) and "Time:" (format: HH:MM in 24 hour time); "Real Time Clock" with a dropdown menu set to "Adafruit PiRTC (pcf8523)" and a note: "NOTE: You must reboot to activate the RTC, then return to this page to set the time on the RTC."; "NTP" with radio buttons for "Enabled:" (selected) and "Disabled:", and an "NTP Server (optional):" input field; and "Time Zone" with a dropdown menu set to "Etc/UTC". A "Submit" button is at the bottom.

Once the F8-B has rebooted, set the current date and time and click on the Submit button. Updating the Software

You should update to the current version of the software. To check for updates click on the Help then About:



On this screen, you will see the FPP Version you are using (in this case it is 3.5.6) and if there is an update available, it will give you a notice. Click on the Manual Update button.

If next to Remote Git Version it says Unknown, that usually means that your network is not set up properly refer to the [Troubleshooting](#) section for help.

About FPP

<p>Version Info</p> <p>FPP Version: v3.5.6</p> <p>FPP OS Build: v3.5</p> <p>OS Version: Raspbian GNU/Linux 10 (buster)</p> <p>Hardware Serial Number: 000000007968ad71</p> <p>Kernel Version: 4.19.75+</p> <p>Git Branch: v3.5</p> <p>Local Git Version: 8c233cd (Update is available) ChangeLog</p> <p>Remote Git Version: 1fld6ec Preview Changes</p> <p>Disable Auto Update: <input checked="" type="checkbox"/> Manual Update</p> <p>System Utilization</p> <p>CPU Usage: 0.00%</p> <p>Memory Usage: 21.49%</p> <p>Uptime</p> <p>23:51:42 up 6:27, load average: 0.26, 0.16, 0.17</p>	<p>Player Stats</p> <p>Playlists: 0</p> <p>Sequences: 0</p> <p>Audio Files: 0</p> <p>Videos: 0</p> <p>Events: 0</p> <p>Effects: 0</p> <p>Scripts: 0</p> <p>Disk Utilization</p> <p>Root Free Space: 52.36 GiB (92%)</p> <p>Media Free Space: 52.36 GiB (92%)</p>
--	--

You will get a progress screen similar to this; it could take several minutes to update:

FPP Manual Update

```
Stopping fppd...
=====
Pulling in updates...
Upgrading git revision from branch v2.5
From https://github.com/FalconChristmas/fpp
 926a5c03..15ce23a8 v2.5      -> origin/v2.5
 b220c744..a13a82d5 master    -> origin/master
 2eee8c92..34a30217 v1.10   -> origin/v1.10
 50b3a89b..10d0ee8d v2.4     -> origin/v2.4
 * [new branch]      v2.6     -> origin/v2.6
 * [new branch]      zstd     -> origin/zstd
 * [new tag]         2.6      -> 2.6
Updating 926a5c03..15ce23a8
Fast-forward
 www/js/fpp.js | 2 +-
 www/menu.inc | 4 +---
 2 files changed, 2 insertions(+), 4 deletions(-)
Synchronizing submodule url for 'external/RF24'
Synchronizing submodule url for 'external/rpi-rgb-led-matrix'
Synchronizing submodule url for 'external/rpi_ws281x'
```

Once it has updated, scroll to the bottom of the screen and click on the Go back to FPP About page.

```
ccache g++ -DUSEHTTAPI -g -I . -I channeloutput -I mediaoutput -Wno-write-strings -Wno-narrowing -DNOROOT -DPLATFORM_BBB -I/usr/local/include -O1 -std=gnu++14 -c Sequence.cpp -o Seq
ccache g++ -DUSEHTTAPI -g -I . -I channeloutput -I mediaoutput -Wno-write-strings -Wno-narrowing -DNOROOT -DPLATFORM_BBB -I/usr/local/include -O1 -c settings.c -o settings.o
ccache g++ -DUSEHTTAPI -g -I . -I channeloutput -I mediaoutput -Wno-write-strings -Wno-narrowing -DNOROOT -DPLATFORM_BBB -I/usr/local/include -O1 -std=gnu++14 -c httpAPI.cpp -o htt
ccache g++ -DUSEHTTAPI -g -I . -I channeloutput -I mediaoutput -Wno-write-strings -Wno-narrowing -DNOROOT -DPLATFORM_BBB -I/usr/local/include -O1 -std=gnu++14 -c channeloutput/BBB4
ccache g++ -DUSEHTTAPI -g -I . -I channeloutput -I mediaoutput -Wno-write-strings -Wno-narrowing -DNOROOT -DPLATFORM_BBB -I/usr/local/include -O1 -std=gnu++14 -c channeloutput/BBB5
ccache g++ -DUSEHTTAPI -g -I . -I channeloutput -I mediaoutput -Wno-write-strings -Wno-narrowing -DNOROOT -DPLATFORM_BBB -I/usr/local/include -O1 -std=gnu++14 -c channeloutput/BBB6
ccache g++ -DUSEHTTAPI -g -I . -I channeloutput -I mediaoutput -Wno-write-strings -Wno-narrowing -DNOROOT -DPLATFORM_BBB -I/usr/local/include -O1 -std=gnu++14 -c channeloutput/BBB7
ccache g++ -DUSEHTTAPI -g -I . -I channeloutput -I mediaoutput -Wno-write-strings -Wno-narrowing -DNOROOT -DPLATFORM_BBB -I/usr/local/include -O1 -std=gnu++14 -c channeloutput/BBB8
ccache g++ -DUSEHTTAPI -g -I . -I channeloutput -I mediaoutput -Wno-write-strings -Wno-narrowing -DNOROOT -DPLATFORM_BBB -I/usr/local/include -O1 -std=gnu++14 -c channeloutput/BBB9
ccache g++ channeloutput/ChannelOutputBase.o channeloutput/ThreadedChannelOutputBase.o channeloutput/channeloutput.o channeloutput/channeloutputthread.o channeloutput/ArtNet.o channe
=====
Restarting fppd...
Update Complete.
Go to FPP Main Status Page
Go back to FPP About page
```

Sometimes there will be an additional update available, if so, click on the Upgrade button.

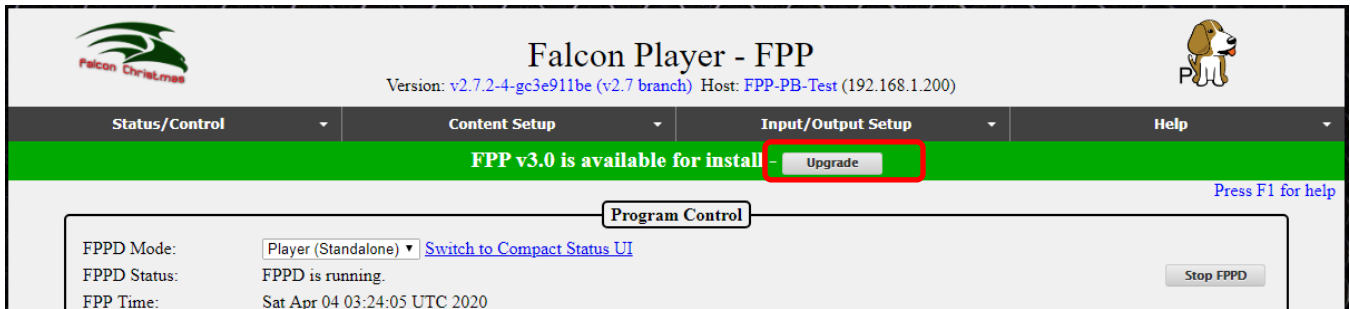

You will usually get a Release notes page, click on the Upgrade button.

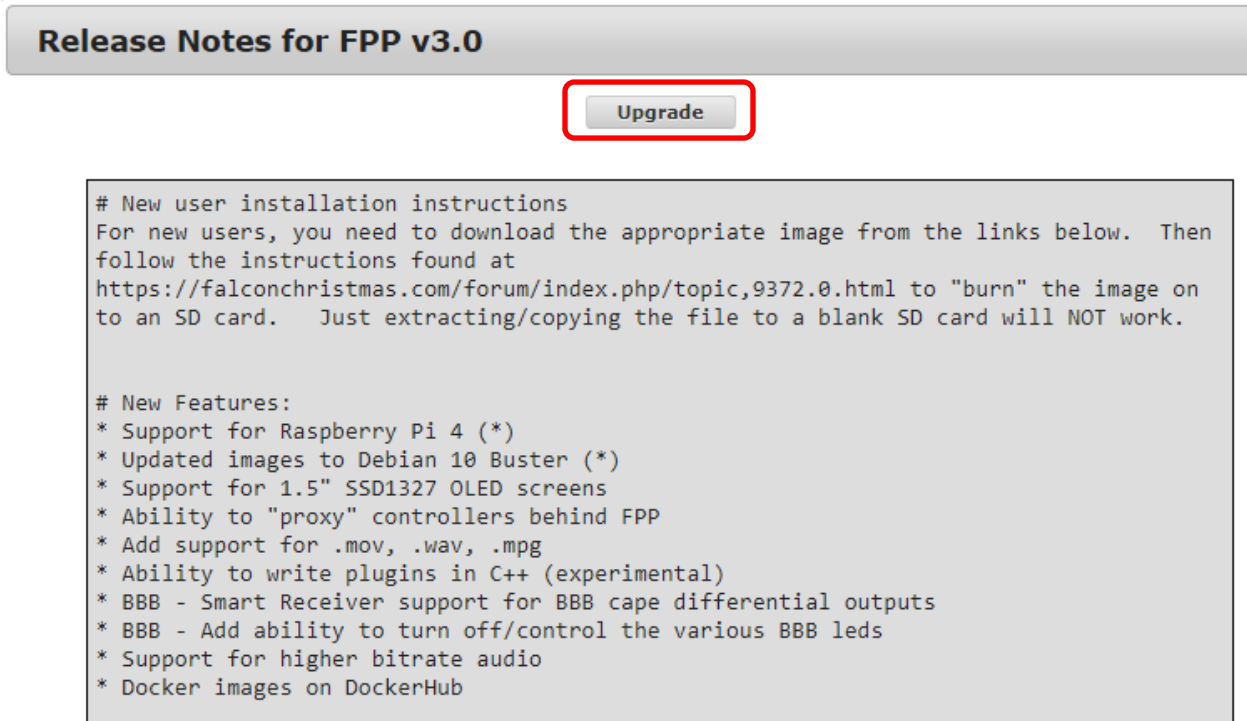

You should get a confirmation page, click OK

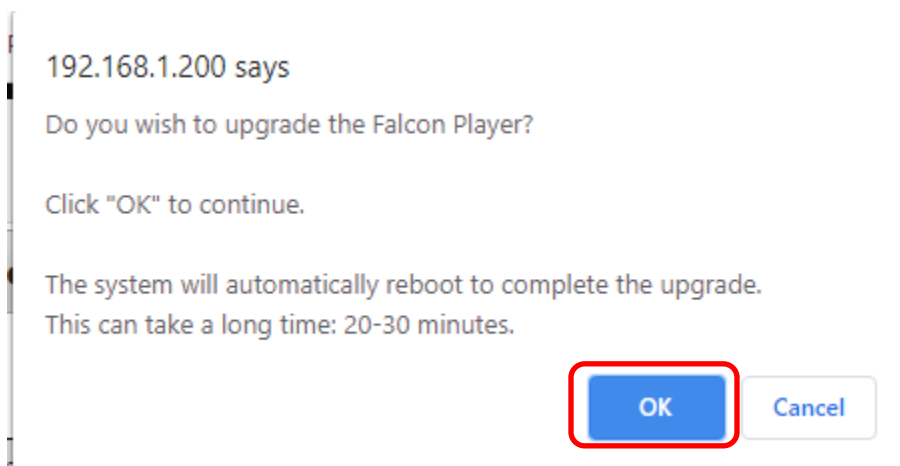

You will get a progress screen similar to this; it could take several minutes to update:

FPP Manual Update

```
Stopping fppd...
=====
Pulling in updates...
Upgrading git revision from branch v2.5
From https://github.com/FalconChristmas/fpp
 926a5c03..15ce23a8 v2.5      -> origin/v2.5
 b220c744..a13a82d5 master    -> origin/master
 2eee8c92..34a30217 v1.10   -> origin/v1.10
 50b3a89b..10d0ee8d v2.4     -> origin/v2.4
 * [new branch]      v2.6     -> origin/v2.6
 * [new branch]      zstd     -> origin/zstd
 * [new tag]         2.6      -> 2.6
Updating 926a5c03..15ce23a8
Fast-forward
 www/js/fpp.js | 2 +-
 www/menu.inc | 4 +---
 2 files changed, 2 insertions(+), 4 deletions(-)
Synchronizing submodule url for 'external/RF24'
Synchronizing submodule url for 'external/rpi-rgb-led-matrix'
Synchronizing submodule url for 'external/rpi_ws281x'
```

Once it has updated, scroll to the bottom of the screen and click on the Go back to FPP About page.

```
ccache g++ -DUSEHTTAPI -g -I . -I channeloutput -I mediaoutput -Wno-write-strings -Wno-narrowing -DNOROOT -DPLATFORM_BBB -I/usr/local/include -O1 -std=gnu++14 -c Sequence.cpp -o Sequence.o
ccache g++ -DUSEHTTAPI -g -I . -I channeloutput -I mediaoutput -Wno-write-strings -Wno-narrowing -DNOROOT -DPLATFORM_BBB -I/usr/local/include -O1 -c settings.c -o settings.o
ccache g++ -DUSEHTTAPI -g -I . -I channeloutput -I mediaoutput -Wno-write-strings -Wno-narrowing -DNOROOT -DPLATFORM_BBB -I/usr/local/include -O1 -std=gnu++14 -c httpAPI.cpp -o httpAPI.o
ccache g++ -DUSEHTTAPI -g -I . -I channeloutput -I mediaoutput -Wno-write-strings -Wno-narrowing -DNOROOT -DPLATFORM_BBB -I/usr/local/include -O1 -std=gnu++14 -c channeloutput/BBB4I.cpp -o channeloutput/BBB4I.o
ccache g++ -DUSEHTTAPI -g -I . -I channeloutput -I mediaoutput -Wno-write-strings -Wno-narrowing -DNOROOT -DPLATFORM_BBB -I/usr/local/include -O1 -std=gnu++14 -c channeloutput/BBB5I.cpp -o channeloutput/BBB5I.o
ccache g++ -DUSEHTTAPI -g -I . -I channeloutput -I mediaoutput -Wno-write-strings -Wno-narrowing -DNOROOT -DPLATFORM_BBB -I/usr/local/include -O1 -std=gnu++14 -c channeloutput/BBB6I.cpp -o channeloutput/BBB6I.o
ccache g++ -DUSEHTTAPI -g -I . -I channeloutput -I mediaoutput -Wno-write-strings -Wno-narrowing -DNOROOT -DPLATFORM_BBB -I/usr/local/include -O1 -std=gnu++14 -c channeloutput/BBB7I.cpp -o channeloutput/BBB7I.o
ccache g++ channeloutput/ChannelOutputBase.o channeloutput/ThreadedChannelOutputBase.o channeloutput/channeloutput.o channeloutput/channeloutputthread.o channeloutput/ArtNet.o channeloutput/ChannelOutput.o -o fppd
=====
Restarting fppd...
Update Complete.
Go to FPP Main Status Page
Go back to FPP About page
```

When the update is complete, the screen will return to the About Page. You can verify that it is up to date. If it is up to date, the Local Git version will be the same as the Remote Git Version.

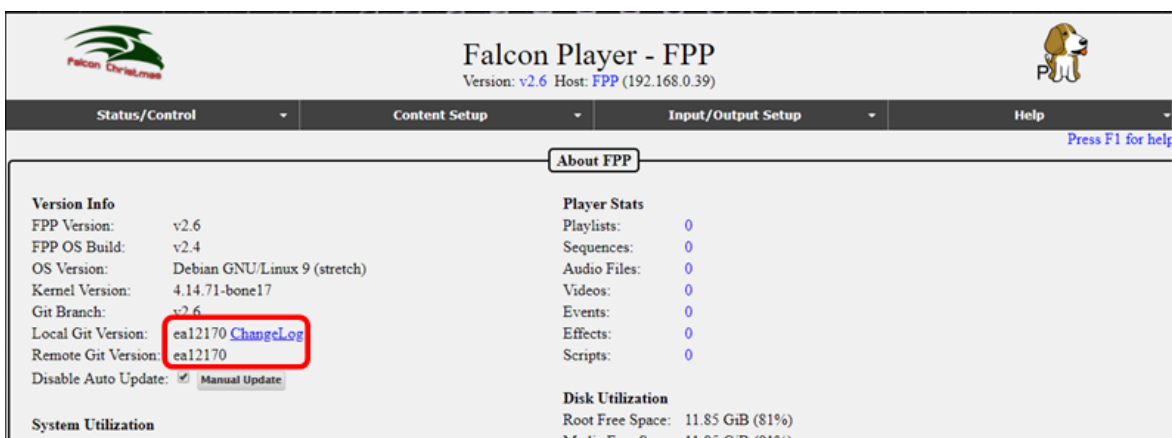

Your FPP software is now installed and up to date. There are many ways that FPP can be used and the settings required to run your show will vary depending on your particular setup. Refer to the appropriate section(s) for more information.

For more configuration and functionality of the FPP software, refer to the FPP Manual located here: https://falconchristmas.github.io/FPP_Manual.pdf

Input/Output Settings

The input and output settings can be exported from xLights to your F8-B as long as the information in the Layout section for each model is completely filled out including the controller connections.

Channel Inputs

Normally you do not need to configure Channel inputs. The only time that you need to configure E1.31 inputs is if you are going to run your F8-B in Bridge Mode and you are using E1.31 data. (DDP data is more efficient and the recommended method. DDP data does not require Channel Inputs to be configured)

E1.31/ArtNet Bridge

E1.31/ArtNet Bridge Mode Universes

Inputs Count:

Line #	Active	Description	FPP Channel		Universe			
			Start	End	#	Count	Size	Type
1	<input checked="" type="checkbox"/>	F16V3 Yard	1	7680	1	15	512	E1.31 - Unicast ▼

(Drag entry to reposition)

Note: If you are using xLights, you can export the E1.31 Bridge configuration into your FPP by using the Upload to Controller Function in the xLights setup section.

Line #- This is just a reference for the line.

Active- You can make the Universes defined on a line active by selecting this box, if you don't want it active, remove the checkmark.

Description- Enter a description to help you identify the controller that these Universes are assigned.

FPP Channel (Start)- Enter the Start Channel that you want these Universes to start, if this is the only controller in your network, then it is typically 1 but if you have more than one controller, you will have to determine what the start channel should be. This can usually be determined from your xLights Setup screen.

FPP Channel (End)- This will be calculated based on the information entered.

Universe (#)- This is the first Universe number that you are assigning. It can be any number and doesn't need to begin at 1.

Universe (Count)- Enter the number of Universes you are going to assign to this FPP device. You can define several Universes on one line (it is the recommended method) Universes do not have a direct correlation to ports, it is recommended to define Universes based

on controllers. In the screenshot above, there are 15 Universe of 512 channels defined (1-15).

Universe (Size)- Enter the number of channels that you want each Universe to have. The common Universe size is either 512 or 510 channels and they both work equally well. Just make sure that you use the same Universe numbers and sizes in all areas related to this FPP device (xLights, etc.)

Universe (Type)- There are 3 Universe types.

- E1.31-Unicast- This is the recommended method.
- E1.31-Multicast- This method is for older controllers that don't perform well under Unicast.
- Artnet- This is for Artnet type controllers (fairly rare these days.)

E1.31 Bridge mode is useful if you want to control your lights/props directly from xLights, xSchedule or other software and is useful in testing from xLights as well. If you are not going to use Bridge Mode, then you don't need to setup any Universes in the Input page but it could be helpful in testing.

Your E1.31 Bridge Universes/FPP Start channels/Universe size needs to match what you setup in your show player (e.g. xLights/xSchedule) and the controller. If you need additional information on Universes, refer to the Resources section about [Universes and Channels](#) in the FPP Manual.

Important! If you change the FPP Start Channel numbers, Universe #, Universe Count or Universe size after you have configured your Universes, make sure that you adjust any of the other Universe Lines because FPP will not "auto correct" your Universe #s or FPP Start Channel numbers.

Adding E1.31 Bridge Mode Input

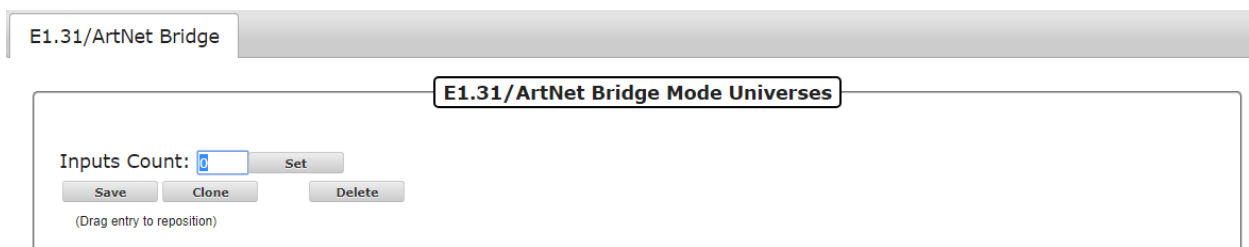

The screenshot shows a software interface for configuring E1.31/ArtNet Bridge Mode Universes. At the top, there is a tab labeled "E1.31/ArtNet Bridge". Below it, a main window titled "E1.31/ArtNet Bridge Mode Universes" contains a form. The form has an "Inputs Count:" label followed by a text input field containing the number "1". To the right of the input field is a "Set" button. Below the input field are three buttons: "Save", "Clone", and "Delete". At the bottom of the form, there is a small instruction: "(Drag entry to reposition)".

If you choose to enter E1.31 Universes manually, you would normally enter 1 for the Inputs count and click on Set. Then enter all of the relevant information in the fields that get displayed.

The Clone button will copy the settings of the selected Line # (Universe #, Universe Count, Universe Size and Universe Type) to the lines below. FPP will then ask how many Universe

lines you want to clone. This is not normally needed with the ability to define several Universes on one line.

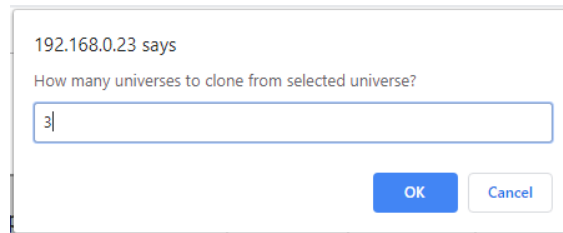

When you click OK, FPP will paste the settings into the number of Universe lines that you entered below the selected Universe line and increment the Universe # on each cloned line.

Note: You have to enter a valid number of Universes to clone. If you select more Universes to clone than there are Universe lines below the selected Universe, then the clone process will not be completed.

You can also delete a Universe line by selecting it and clicking on the Delete button.

Important! You have to click on the Save button after you make any changes in order for them to be saved. After you save the configuration, you will get a message at the top of your screen indicating that you have to restart FPP for the change to take effect.



Channel Outputs

The Channel Outputs page is where you configure FPP to output the channel data it receives to the various controllers/hats/capes that are connected to the FPP. There are several types of output configurations and you will have to configure the output that is appropriate for your application.

Note: If you are using xLights, you can use FPP Connect to upload your output channels as long as you completely configure your models to include the controller connections.

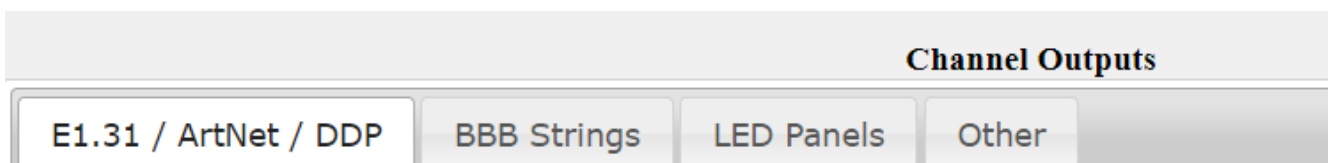

You will need to setup your channel outputs to match the controller that is connected to your FPP device.

Here are the Channel output types and typical usage.

- E1.31/ ArtNet/ DDP- The F8-B will rarely be used to output this type of data.
- BBB Strings- This is the section that is normally used for your configuration.
- LED Panels- The F8-B cannot be used to output LED Panel data.
- Other-There are several other output types that are not commonly used but available, such as DMX Pro, LOR, Renard to name a few.

BBB Strings

The BBB Strings page is where you will probably do most of your configuration.

BeagleBone String Capes

Enable BBB String Cape: Press F2 to auto set the start channel on the next row.

Cape Type: FB-PB w/ Expansion (8 Serial) ▼

Clone String Save Revert

Port	Description	Start Channel	Pixel Count	Group Count	End Channel	Direction	Color Order	Null Nodes	Zig Zag	Brightness	Gamma
1) ●		1	0	0	0	Forward ▼	RGB ▼	0	0	100% ▼	1.0
2) ●		1	0	1	0	Forward ▼	RGB ▼	0	0	100% ▼	1.0
3) ●		1	0	1	0	Forward ▼	RGB ▼	0	0	100% ▼	1.0
4) ●		1	0	1	0	Forward ▼	RGB ▼	0	0	100% ▼	1.0
5) ●		1	0	1	0	Forward ▼	RGB ▼	0	0	100% ▼	1.0
6) ●		1	0	1	0	Forward ▼	RGB ▼	0	0	100% ▼	1.0
7) ●		1	0	1	0	Forward ▼	RGB ▼	0	0	100% ▼	1.0
8) ●		1	0	1	0	Forward ▼	RGB ▼	0	0	100% ▼	1.0
Differential Receiver: Standard ▼											
9) ●		1	0	1	0	Forward ▼	RGB ▼	0	0	100% ▼	1.0
10) ●		1	0	1	0	Forward ▼	RGB ▼	0	0	100% ▼	1.0
11) ●		1	0	1	0	Forward ▼	RGB ▼	0	0	100% ▼	1.0
12) ●		1	0	1	0	Forward ▼	RGB ▼	0	0	100% ▼	1.0
Expansion Type: Standard ▼											
13) ●		1	0	1	0	Forward ▼	RGB ▼	0	0	100% ▼	1.0
14) ●		1	0	1	0	Forward ▼	RGB ▼	0	0	100% ▼	1.0
15) ●		1	0	1	0	Forward ▼	RGB ▼	0	0	100% ▼	1.0
16) ●		1	0	1	0	Forward ▼	RGB ▼	0	0	100% ▼	1.0
17) ●		1	0	1	0	Forward ▼	RGB ▼	0	0	100% ▼	1.0
18) ●		1	0	1	0	Forward ▼	RGB ▼	0	0	100% ▼	1.0
19) ●		1	0	1	0	Forward ▼	RGB ▼	0	0	100% ▼	1.0
20) ●		1	0	1	0	Forward ▼	RGB ▼	0	0	100% ▼	1.0
21) ●		1	0	1	0	Forward ▼	RGB ▼	0	0	100% ▼	1.0
22) ●		1	0	1	0	Forward ▼	RGB ▼	0	0	100% ▼	1.0
23) ●		1	0	1	0	Forward ▼	RGB ▼	0	0	100% ▼	1.0
24) ●		1	0	1	0	Forward ▼	RGB ▼	0	0	100% ▼	1.0
25) ●		1	0	1	0	Forward ▼	RGB ▼	0	0	100% ▼	1.0
26) ●		1	0	1	0	Forward ▼	RGB ▼	0	0	100% ▼	1.0
27) ●		1	0	1	0	Forward ▼	RGB ▼	0	0	100% ▼	1.0
28) ●		1	0	1	0	Forward ▼	RGB ▼	0	0	100% ▼	1.0

Serial Mode: Disabled ▼

If you do not send any serial data then you will have all the RJ45 ports available to connect Differential Receivers. Each RJ45 port can connect to one Differential Receiver or up to 3 daisy-chained Smart Differential Receivers with an Ethernet cable up to 250 feet to the furthest Receiver. The Differential Receivers and Smart Differential Receivers each have 4 ports for pixel string connections.

At the top of the page, you have the following options:

- Enable BBB String Cape- If you are using a BBB Cape then this box needs to be checked
- Cape Type- You will need to select the type of Cape that you are using and the type of output you are going to use.
 - If you are not going to use the serial ports for DMX/Pixelnet output then select one of the (No Serial) options.
 - If you are going to use one of the DMX/Pixelnet RJ45 output (Port A-4 Universes) then select one of the (4 Serial options.)
 - If you are going to use both of the DMX/Pixelnet ports the select one of the (8 Serial) options.
 - If you are going to use one of the Expansion Boards, select one of the w/ Expansion options.
- Clone String- If you select a string port, you can clone the data to the string ports below. Once you select a string port, click on the Clone String button and you will be asked how many copies of the string you want to clone below the selected string.
- Save- This will save your settings
- Revert- This will revert to the last saved settings.
- Press F2 to auto set- When you complete a row of the configuration, you can press F2 and it will fill in the start channel on the next row. This is helpful if you have several ports that are running contiguous channels.

You can add only one Expansion Board or one Differential Expansion Board to the F8-B.

- Expansion Board- This will add 16 more ports to be connected locally.
- Differential Expansion Board- This will add the ability to add up to 4 Differential Receivers. Each Differential Receiver has 4 ports and each Differential Receiver can be located up to 250 feet from the F8-B with an Ethernet cable connecting them. If you use Smart Differential Receiver boards, then you can add up to 3 Smart Differential Receiver boards to each RJ45 port of the Differential Expansion board by connecting them in a daisy chain.

Each port on all of the controllers/receivers have the following options:

- Description- You can enter a description for the pixels attached to the port.

- Start Channel- Enter the start channel that corresponds to the start channel in your sequencing software (xLights, Vixen, etc.)
- Pixel Count- Enter the number of pixels connected to that port of the hat.
- Group Count- If you have groups of pixels that are going to be illuminated exactly the same all of the time, you can put them in groups.
- End Channel- This indicates the ending channel for the string.
- Direction- Selecting reverse will reverse the data sent to the pixels so that it will act like the data is coming in from the end of the string.
- Color Order- You can select a color order to match the color order for the pixels you are using.
- Null Nodes- If you are using Null Nodes in the beginning of your string to help boost the transmission distance, then enter the number of Null Nodes you have in the string.
- Zig Zag- This setting is useful for items like a Mega Tree where one string is used for more than one strand of the tree. This is more commonly setup in the sequencing software (xLights, Vixen, etc.) Enter the number of times the string changes direction.
Do not use Zig Zag if you used the Strands/String setting in your sequencing software.
- Brightness- You can set the brightness for your pixel string. Many dense props are very bright and a lower brightness might look better. This also reduces the power required to light the pixels.
- Gamma- This is a correction factor that can be entered due to the way that our eyes perceive colors in the dark. . It can also be used to correct color variations on pixel strings from different vendors

If you are using the Serial output ports, you will configure those at the bottom of the screen.

Enable BBB String Cape:

Cape Type:

Press F2 to auto set the start channel on the next row.

Port	Description	Start Channel	Pixel Count	Group Count	End Channel	Direction	Color Order	Null Nodes	Zig Zag	Brightness	Gamma
1)		1	0	1	0	Forward	RGB	0	0	100%	1.0
2)		1	0	1	0	Forward	RGB	0	0	100%	1.0
3)		1	0	1	0	Forward	RGB	0	0	100%	1.0
4)		1	0	1	0	Forward	RGB	0	0	100%	1.0
5)		1	0	1	0	Forward	RGB	0	0	100%	1.0
6)		1	0	1	0	Forward	RGB	0	0	100%	1.0
7)		1	0	1	0	Forward	RGB	0	0	100%	1.0
8)		1	0	1	0	Forward	RGB	0	0	100%	1.0
Differential Receiver: <input type="text" value="Standard"/>											
9)		1	0	1	0	Forward	RGB	0	0	100%	1.0
10)		1	0	1	0	Forward	RGB	0	0	100%	1.0
11)		1	0	1	0	Forward	RGB	0	0	100%	1.0
12)		1	0	1	0	Forward	RGB	0	0	100%	1.0

Serial Mode:

Set the Serial Mode to the Serial mode that you are going to output, either DMX or Pixelnet. A configuration screen will become available to enter the channel information for your DMX/Pixelnet outputs.

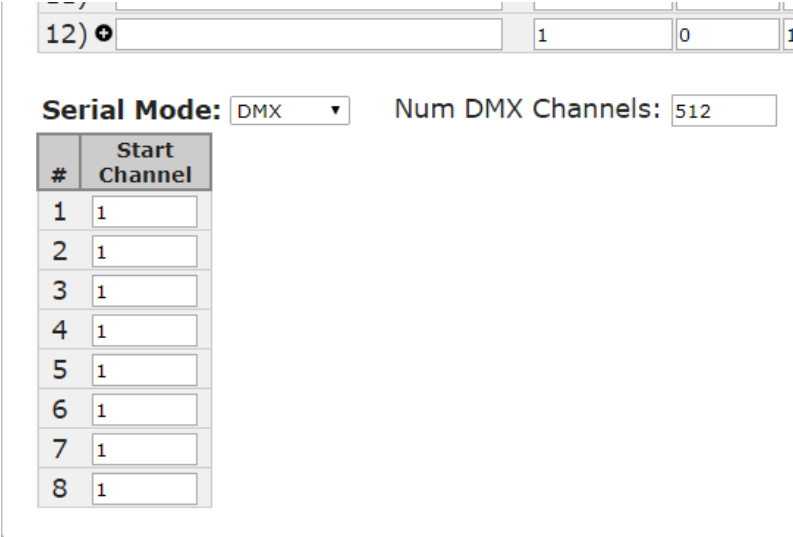

12) + 1 0 1

Serial Mode: DMX Num DMX Channels: 512

#	Start Channel
1	1
2	1
3	1
4	1
5	1
6	1
7	1
8	1

Network Installation

Installing and configuring the FPP software through a network connection can be accomplished almost as easily as the USB Tethering method. To install and configure your F8-B using a Network Connection requires you to connect your FPP device to your local network via an Ethernet cable using a USB-Ethernet adapter.

1. Make sure the uSD card with the proper image is inserted into the slot.
2. Make sure you have any network adapters that you will need for your network configuration.
3. Connect the F8-PB to your router (not computer) with the Ethernet cable.
4. Connect the appropriate power to the device (not a USB cable to your computer).
5. Wait approximately one minute.
6. Enter <http://fpp> or <http://fpp.local/> in your browser. (If you are unable to connect to the FPP device using one of these addresses, go to the [Troubleshooting](#) section.)
7. Continue to the [Initial Configuration](#) section of the manual to complete the setup.

OLED Operation

The OLED display is useful for checking the status of your F8-B and can be used in conjunction with the push buttons to navigate through the menu items. The OLED screen will go blank

after it has been idle for a while to prevent “burn in.” Pressing either button will activate the screen.



There are two push buttons located near the Ethernet port and are used to navigate through the different menu items.

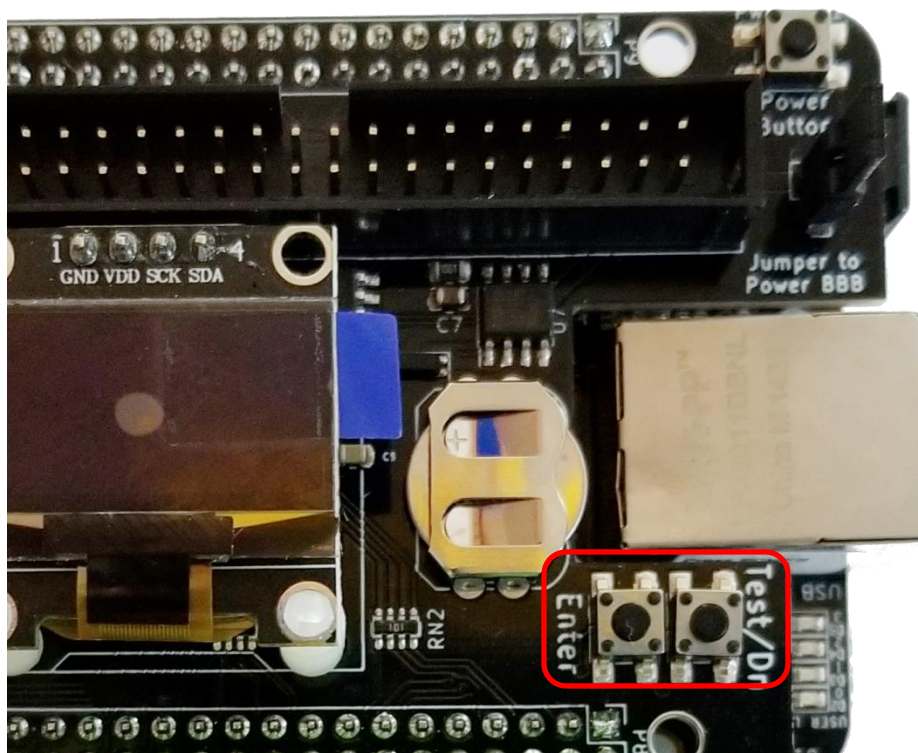

The button on the right is to navigate through the menu items or to display a test pattern if pressed from the Main screen. The button on the left is to select the highlighted item.

Standby Screen

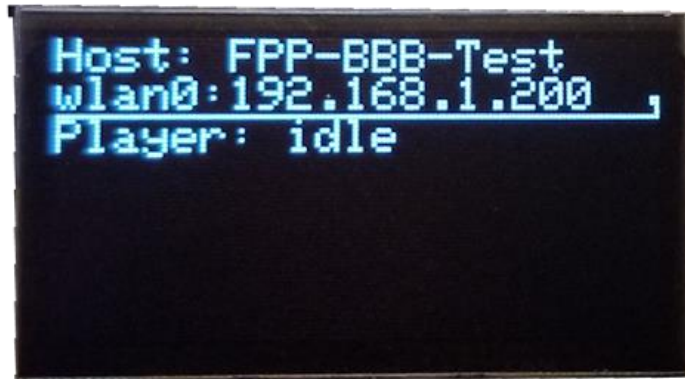

If you press the button on the right, labeled Test/Down, while the OLED display is on the Standby screen then the F8-B will go into test mode and output a test pattern to the **configured** output ports. It will display alternating test patterns. It will cycle through a Red-Green-Blue cycle then go to a Red-Green-Blue-White-Off cycle and then turn off and then cycle again. The OLED will show the FPP in testing mode.

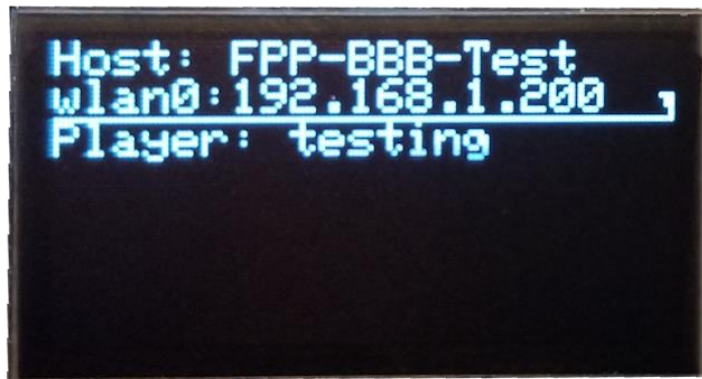

Pressing the button on the left, labeled Enter, while the OLED display is on the Standby screen will open the Status Screen.

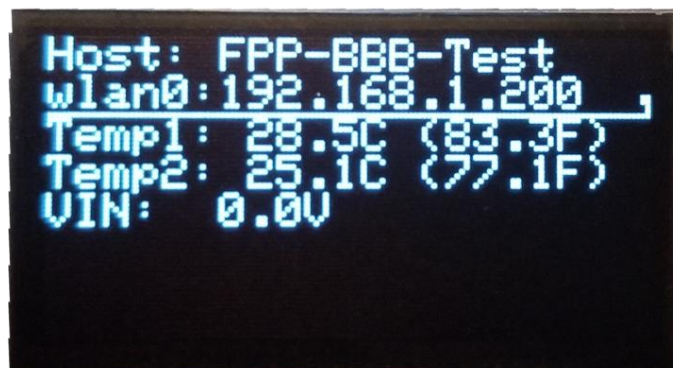

Pressing the Enter button again will take you to the Main Menu.

Main Menu

The Main Menu has several Sub-Menus, to move down the list, press the Test/Down button, to select the item highlighted, press the enter button.

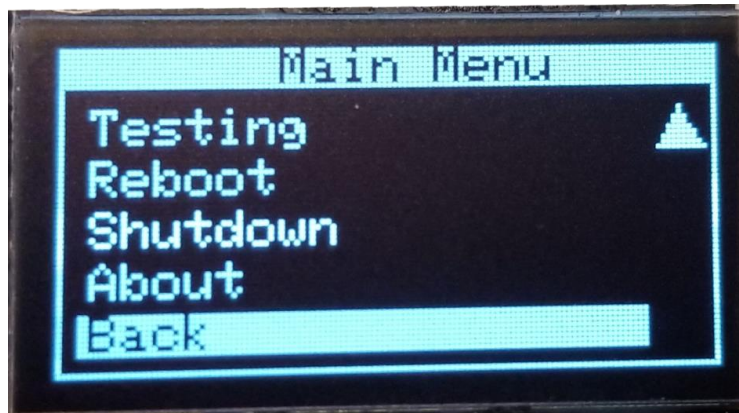
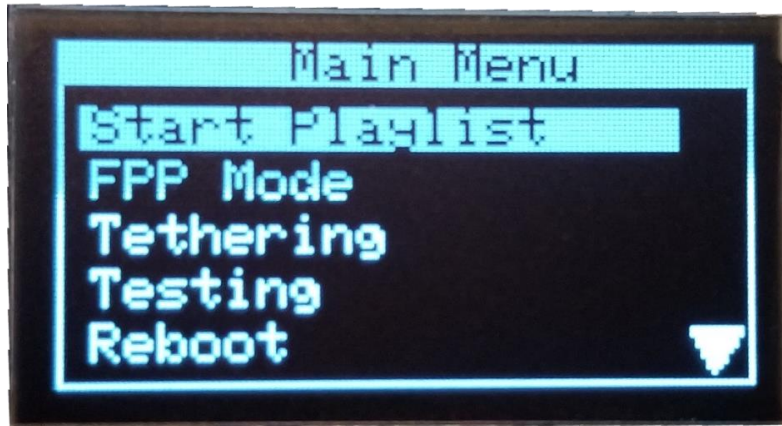

Start Playlist

From this screen you can start or stop playlists that are stored on this FPP Device. There are 2 Stop actions:

- Stop Now- Will end the sequence immediately
- Stop Gracefully- Will complete the currently playing song and then stop.



FPPD Mode

You can select the mode that you want the F8-B to operate in.



- Standalone-This setting is used when this FPP is going to operate without any interaction from an outside source like xSchedule, xLights, or another FPP. This is commonly used if you only have one FPP in your show and have a playlist and schedule set up, or if you have an independent display that is not synchronized to the rest of your show. You will also need to have the appropriate Channel Outputs setup.
- Master-This setting is used if you are going to have more than one FPP and you want them to all be synchronized. The Master will need a copy of the sequences (.fseq) and media (music) files. The Master FPP will also be where your Playlists and Schedules are created. The Remotes that you want to be synchronized need to be identified in the MultiSync page as well. If the Master is also connected to a controller then the appropriate Channel Outputs will need to be setup.
- Remote-This setting is used if you are going to synchronize this FPP and attached controller to a Master FPP. The Remote will need a copy of all the sequences (.fseq) that are going to be played. If the remote is going to be projecting videos to a projector, the video file will need to be saved on the remote as well. You will also need to have the appropriate Channel Outputs setup.
- Bridge-This setting is used to accept E.131 or DDP input data and pass them on to the attached controllers (i.e. Bridge). This is typically used for testing directly from XLights without creating a sequence.

Tethering

You can select the Wi-Fi tethering option. This could be useful if you are having problems connecting to the F8-B due to mis-configured network settings.

Note: Not all Wi-Fi adapters support Wi-Fi tethering so you might not be able to use Wi-Fi tethering.

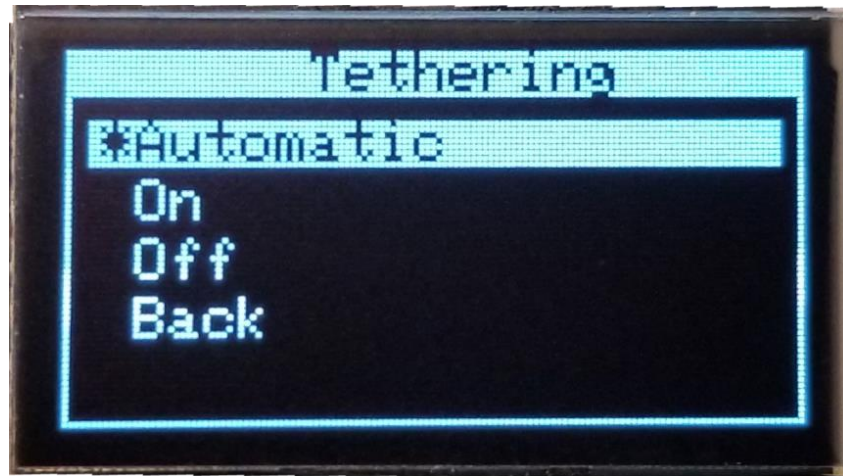

There are 3 WI-FI tethering modes available

- Automatic-This is the default setting. If the FPP device does not detect a network connected to any of the network ports, it will activate a Wi-Fi access point when it powers up called FPP.
- On-When this option is selected; the FPP device will boot up and activate the Wi-Fi access point.
- Off-When this option is selected; the Wi-Fi access point will not be activated.

Testing

The testing function can help you test pixel strings and port connections. There are several test patterns to choose from.

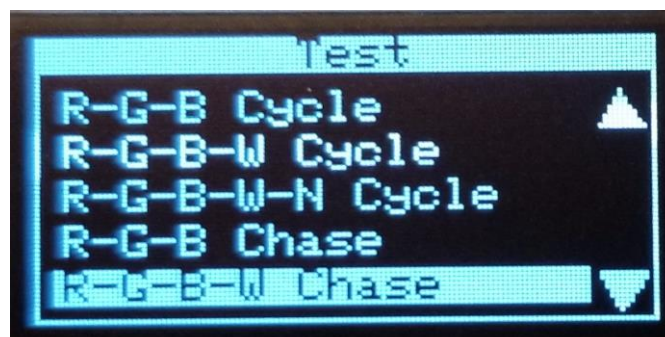
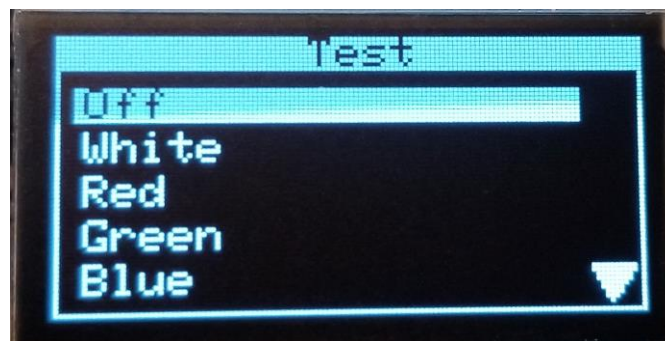

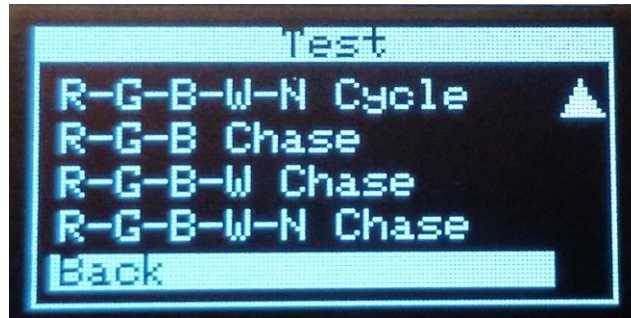

Reboot

You can reboot your F8-B from the reboot screen.



Shutdown

You can shut down your FPP device from the Shutdown screen.



About

The about screen will show you the version and branch that your FPP device is running.

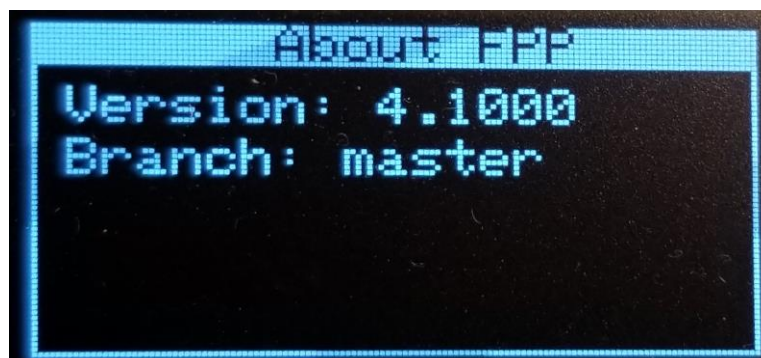

Troubleshooting

Here are a few of the more common problems and their solution.

Symptom	Possible Causes	Remedy
You can't access the FPP device during the USB Tether installation process.	1. The FPP device doesn't have power.	Make sure that the FPP Device is connected via a USB cable to the computer and the power indicator on the FPP device is illuminated.
	2. The USB cable is faulty.	There are some USB cables that are for charging only. Use another cable that is known to be working.
	3. Incorrect IP Address for USB Tethering	When using the USB Tethering method to access your FPP device, you can't use the HostName of the device, you have to use the tethering IP address. If you are using a Windows computer, the IP address is 192.168.7.2 If you are using a Mac or Linux computer, the IP address is 192.168.6.2
	4. You are trying to access the FPP device directly.	You do not access the FPP interface directly; you have to connect through a web browser like Google Chrome.
	5. The image on the uSD card is corrupt.	Format and Re-image the uSD card following the procedures in the Installing Software section
	6. The uSD card is faulty.	Format and Re-image a known good uSD card following the procedures in the Installing Software section
You can't access the FPP device during the Networked installation process.	1. The FPP device doesn't have power.	Check that the power is connected and the power LED is lit on the FPP Device.

2. The Ethernet cable is faulty.	Test your Ethernet cable or use a known good one.
3. The Ethernet cable is not fully inserted into the RJ45 jacks	Check that the cables are fully inserted at both ends.
4. The Ethernet cable is plugged into the wrong port on the router.	Make sure that the cable is inserted into a LAN port and not a WAN port on your router.
5. The pins in the RJ45 connector are damaged.	Conduct a visual inspection to make sure the pins are not bent or missing.
6. You are trying to access the FPP device directly.	You do not access the FPP interface directly; you have to connect through a web browser like Google Chrome.
7. You are using the wrong Host Name.	The correct Host Name for accessing a fresh install is http://fpp/ or http://fpp.local/ If you have other FPP devices on your network then the Host Name access might not work. Refer to the next item, DNS not resolving local names.
8. DNS not resolving local names.	Sometimes a router will not resolve DNS host names (like http://fpp/) so you have to enter the IP address for the FPP Device. This entails accessing your router and might be a little technical for some. Log in to your router's administration page (many times the log in information will be on a sticker on the router, if not, look up the default log in for your brand router) Once you log in, there should be a device table or a

		connected devices section (What it is called depends on the router.) You should see a device labeled FPP, enter the IP address associated with the FPP device.
	9. The FPP device doesn't have a good network connection.	Look in your available networks on your computer and see if there is an entry for FPP, if so, then the FPP device could not communicate with your network. Check all cables. Another issue is that the network you are connecting to is on a 192.168.7.xxx subnet.
	7. The image on the uSD card is corrupt.	Format and Re-image the uSD card following the procedures in the Installing Software section
	8. The uSD card is faulty.	Format and Re-image a known good uSD card following the procedures in the Installing Software section
You can't access the FPP device during the Wi-Fi Tether installation process.	1. The FPP device doesn't have power	Check that the power is connected and the power LED is lit on the FPP Device.
	2. The FPP device doesn't broadcast the FPP network.	<ol style="list-style-type: none"> 1. The FPP device is connected to a network of some kind. Make sure that you do not have the FPP device connected via Ethernet to any device or USB cable to your computer. 2. The FPP Device doesn't have a Wi-Fi adapter. Make sure that your FPP device has a Wi-Fi Adapter 3. Your Wi-Fi adapter does not support Wi-Fi tethering. Many USB based Wi-Fi adapters do not support Wi-Fi tethering. (on board Wi-Fi adapters on the Raspberry Pi and BB wireless versions supports Wi-Fi tethering)
	3. The FPP device broadcasts the FPP network but you cannot connect to the FPP	Your Wi-Fi adapter does not support Wi-Fi tethering. Many USB based Wi-Fi adapters do not support Wi-Fi tethering. (on board Wi-Fi adapters on the Raspberry Pi and BB wireless versions supports Wi-Fi tethering)

network.	
4. The image on the uSD card is corrupt.	Format and Re-image the uSD card following the procedures in the Installing Software section
5. The uSD card is faulty.	Format and Re-image a known good uSD card following the procedures in the Installing Software section